

Framery Four Accessible™

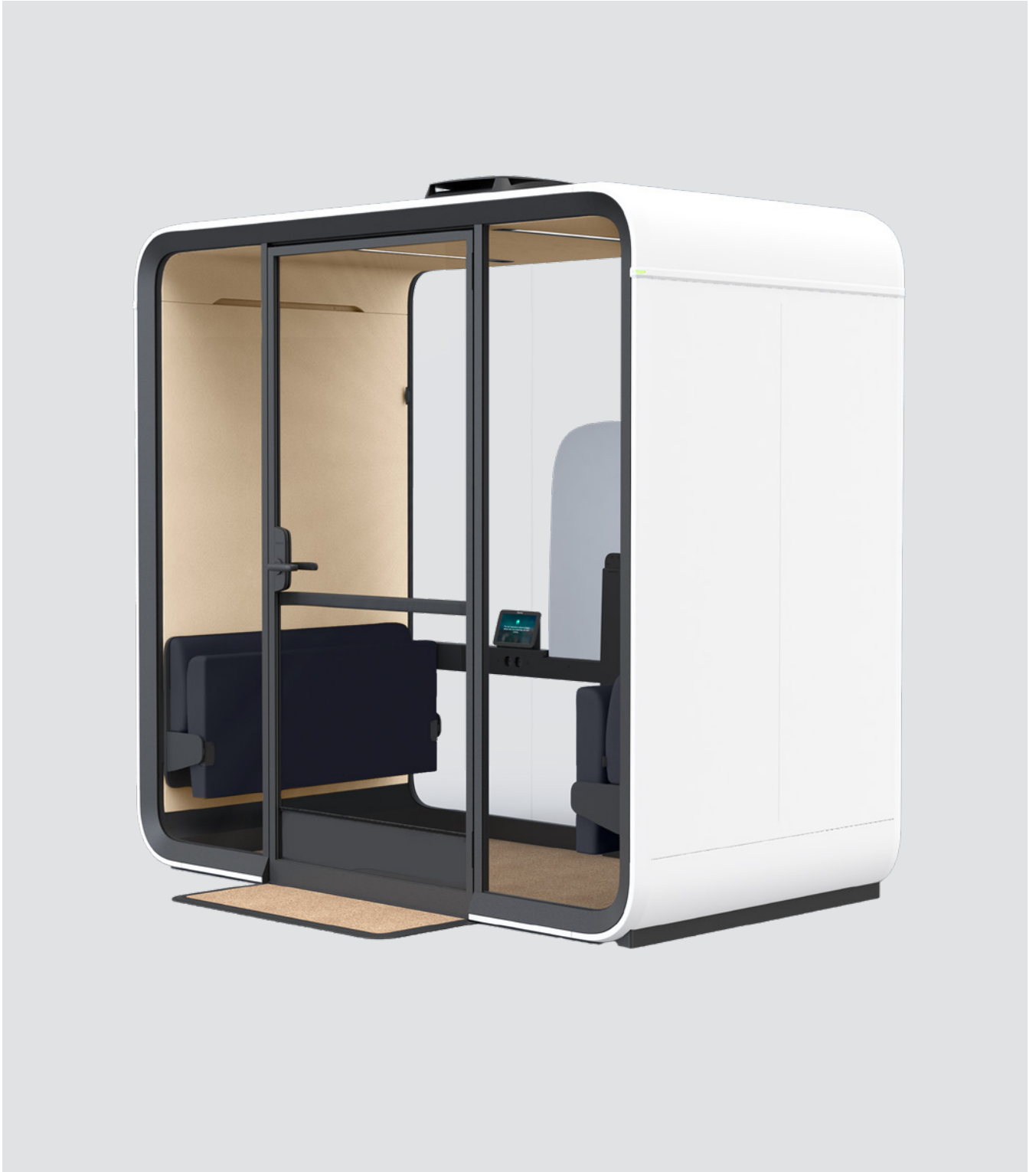

The smart and accessible soundproof meeting pod

framery™



Framery Four Accessible is a fully accessible smart office meeting pod. This soundproof meeting space is ADA compliant - featuring folding furniture, a low threshold, and a T-shaped turning space. Packed with the same advanced technology and functionality as the entire line of Framery smart pods, Framery Four Accessible is a comfortable, adaptive, and multifunctional space for meetings and hybrid work.

Framery Four Accessible / Product highlights



Workdays that flow with ease

Framery Four Accessible has been purposefully designed to make your workdays flow better. Find and book the pod in advance or on-the-fly from the Framery app. Or step inside and the pod automatically creates a reservation for you. Extend your reservation directly from the pod's touchscreen, or adjust your booking through the Framery app.



Privacy you can trust

The fine-tuned acoustic structure provides A-Class soundproofing that allows the pod to be placed next to workstations without causing noise distractions to the user or to those outside of the pod. And echo-free interior acoustics make the pod a private, comfortable place for work and video calls.



Airflow that keeps you fresh

The pod recognizes when it's occupied, senses the temperature and humidity of the surroundings, and triggers adjustments to the airflow accordingly. Enhanced ventilation fully refreshes the air every minute, and ventilation can be easily adjusted through the pod's touchscreen display.



Lighting that makes you feel good

Multiple automated light sources adapt to your needs, with preset lighting options to choose between work or video modes. Video-optimized lighting helps you shine on video calls. Adjustments can be made quickly and easily through the touchscreen display.

Framery Four Accessible / Tech features



1. A-CLASS SOUNDPROOFING

Guaranteed privacy with fine-tuned Class A speech level reduction of 30dB - and the industry's top ISO 23351-1 rating for office meeting pods.

2. FRAMERY OFFICE SOUND MASKING SYSTEM™

The embedded system is based on patent-pending technology that reduces noise distractions and protects speech privacy in office environments by adding a subtle, unobtrusive background sound outside of the pod. This ambient background noise, similar to air flow, is specifically designed to blend in with the office's noise atmosphere - making sounds less intelligible and therefore less distracting.

3. ADAPTIVE VENTILATION

Proprietary design enables unparalleled ventilation with maximum airflow of 100 l/s - surpassing industry standards around the world.

4. TEMPERATURE & HUMIDITY SENSORS

Sensors inside the pod recognize the temperature and humidity of the office environment, and automatically optimize the airflow accordingly

5. AUTOMATIC LIGHTING MODES

Dual adjustable 4000K LED light sources allow you to seamlessly switch between video or work modes - or make manual adjustments for personalized illumination.

6. 8-INCH TOUCHSCREEN

An intuitive, 8-inch high-resolution touchscreen makes it easy to control pod settings, adjust lighting and airflow, and extend calendar reservations effortlessly.

7. AUTOMATIC UPGRADES

A built-in 4G connection enables automatic over-the-air software updates - initiated instantly and silently in the background.

8. MMWAVE RADAR PRESENCE DETECTION

Millimeter-wave radar sensors immediately detect when someone enters or leaves the pod, allowing lighting and ventilation to adjust accordingly.

Occupancy data is gathered and displayed through Framery Connect to provide information about when the pod is being used the most.

9. FRAMERY CONNECT™

Gain insights from occupancy data, initiate advanced bookability functionalities, and connect your Framery Four to the entire office to get valuable usage data needed to improve the layout and efficiency of your workplace.

Framery Four Accessible / Design details

Designed according to ADA standards, Framery Four Accessible combines the sophisticated engineering of Framery smart pods with accommodating features to improve usability even further. A door opening ratio of 180°, a structured black metal pull bar, and an easy-to-reach accessory rail make Framery Four Accessible an equitable private space for every user.



Framery Four Accessible features a face-to-face layout designed to support better meetings. The meeting pod is furnished with a sturdy table and comfortable twin sofas that easily fold up to enable access to the pod and create a T-shaped turning space.



Designed for modern work, Framery Four Accessible utilizes advanced technology to create the perfect atmosphere for any meeting. With the industry's most powerful adaptive ventilation system, video-optimized lighting, and two preset lighting modes for video or focused work.



The low threshold (1.25 cm / 0.5 in) and the external platform makes it easy to access the pod with a wheelchair.



Outlets, charge ports, and an 8-inch touchscreen are embedded in a convenient accessory bar and placed within operative height.



The door has a door opening ratio of 180° and sturdy black metal pull bar for opening and closing the door effortlessly.



The folding table serves as a functional work desk. The folding sofas have been designed without compromising the seating comfort.

Framery Four Accessible / Colors and finishes

EXTERIORS

	White RAL 9016 Ultramatt
	Black RAL 9005 Ultramatt
	Gray S 7500 - N Ultramatt
	Navy S 7020 - R90B Ultramatt
	Sand S 2010 - Y20R Ultramatt
	Powder Blue 3421-R86B Ultramatt
	Winter Moss S 7010-G10Y Ultramatt
	Blush 2728-R01B Ultramatt

CARPETS

	Light Gray Ex-dono Quartet #393330 Fletco carpets
	Dark Blue Zenith #T371880 Fletco carpets
	Champagne Zenith #T371210 Fletco carpets
	Grape Zenith #371680 Fletco carpets





TABLE TOPS

	White White laminate
	Black Black Laminate with anti-fingerprint surface
	Oak Veneer

SEATING FABRICS

	Graphite Select #60051 Gabriel
	Dark Blue Select #66144 Gabriel
	Grape Select #61190 Gabriel
	Rose Select #65117 Gabriel
	Powder Blue Select #67098 Gabriel
	Beige Select #61184 Gabriel
	Green Selected #68209 Gabriel
	Mustard Select #62098 Gabriel

INTERIORS

	Pure Gray Tonal #60123 Gabriel
	Arctic Blue Tonal #66185 Gabriel
	Sand Tonal #61180 Gabriel
	Rouge Tonal #64210 Gabriel

MATERIALS AND FINISHES



EXTERIOR PANELS made from steel feature a powder-coated matt finish. The lightweight panels are joined together seamlessly with elegant curves that create a timeless design.



INTERIOR PANELS made from high-quality and recycled polyester have a vibrant and dynamic look thanks to the mix of the two-colored fabric.

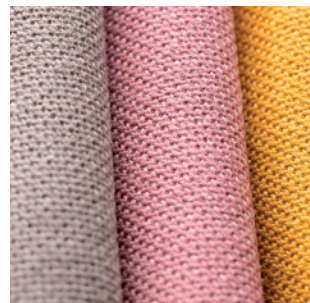

SEATING MATERIALS are a blend of superior New Zealand wool and polyamid that form a soft and rich texture. The extremely durable fabrics are both dirt and water repellent.



CARPET FLOORING is anti-static, stain resistant, and durable, giving the pod an overall soft look and finish.

Framery workplace technology / Set your office up for success

Framery's workplace technology suite streamlines workdays, elevates productivity, and enhances the entire workplace experience. Access real-time occupancy data, make data-driven decisions, book meeting spaces easily, and boost focus, privacy, and productivity throughout the office. Set up your workplace for the people who use it – making it easier than ever to get work done. And you can enjoy these benefits without any deployment costs.

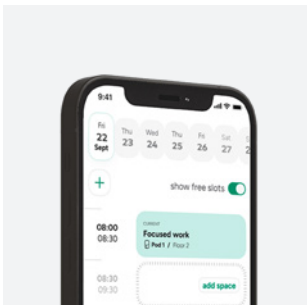

Framery App™

Manage your workday on the go with the Framery app – the easiest way to book pods and meeting spaces for every task throughout your day. Instantly check space availability and save your favorite spaces to see when they're free. Book spaces in advance or on the go directly from your phone, and manage your entire workday in one place.



Framery Office Sound Masking System™

The Framery office sound masking system improves the acoustics of the entire workplace. The embedded system is based on patent-pending technology that reduces noise distractions and protects speech privacy in office environments by adding a subtle, unobtrusive background sound outside of the pod. This ambient background noise, similar to air flow, is specifically designed to blend in with the office's noise atmosphere – making sounds less intelligible and therefore less distracting.

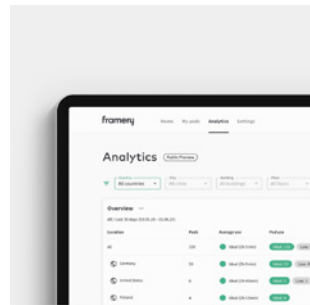

Framery Connect™

Make workplace management decisions based on insights from your office's occupancy data. Every connected space provides you with valuable usage data you need to improve the layout and efficiency of your workspace. See which spaces are functioning efficiently, which spaces need attention, and which spaces go unused. With real-time usage data you can provide enough spaces in the right places.



Framery Connect Sensor™

This palm-sized sensor expands the capabilities of Framery Connect – making it possible to collect usage data from any space in your workplace. From meeting rooms to collaborative spaces, the sensor can easily be attached to any space in your office to give you a complete overview of how your office is used. The simple and wireless sensor is equipped with internal 4G connectivity and an external battery boasting a 3-year battery life.

Unparalleled support

Get instant support from a Framery specialist for any issues that may arise with your smart pods or other products.

Always updated

Instantly receive software updates through your smart pod's 4G connection to enable developments and services into the future.

Privacy ensured

No identifiable user data is collected – only workspace occupancy information is tracked.

FRAMERY PLUS – EVERYTHING YOU NEED FOR A SUCCESSFUL WORKPLACE

Unlock all the tools and features your workplace needs to thrive with our subscription based Framery Plus™ – free of charge until the end of 2024.

Framery smart pods / Environmental data sheet

Framery's new smart pods set the standard in sustainability – with durability that is measured in decades, light-weight product structures, use of truly recyclable materials, and modularity that allows the life cycle of the products to be extended indefinitely. Framery participates in the Science Based Targets initiative, and has set emission reduction targets aligned with the goal of limiting global warming to 1.5°C compared to pre-industrial levels. Results of life cycle assessment of Framery products are verified by an independent third party and available in Environmental Product Declarations.



Optimal material use

Framery has achieved a 23% material reduction with its new line of products – which equals over 1 million kg of raw material annually – while increasing their level of performance compared to previous models. This has made it possible for Framery to reduce product prices as well. The carbon footprint in the manufacturing stage of the new products is 16% smaller on average. A change from plywood to steel as the main construction material also allows Framery to continue reducing its environmental impact and strive towards a 50% reduction in product CO₂ emissions by 2028.



Production and waste management

All our pods are manufactured in Tampere, Finland using zero-emission electricity. Our factory logistics are operated on biogas and renewable diesel. The material efficiency rate of our production was 94.9% in 2022. Virtually no waste goes to landfill.



Environmental impact

We have conducted life cycle assessment studies for our products to measure their environmental impacts. Alongside their carbon footprint, we also study other impacts such as resource depletion and water scarcity. The results are verified by an independent third party, and then published and registered as an EPD to provide stakeholders with reliable information on our products' environmental performance in a transparent way.



Product performance

The modular design of our pods facilitates a long product lifetime, and our customers typically use them for many years. The same pod can be used by one customer after another, enabling multiple life cycles and saving valuable resources. Thanks to their modular design, our pods are easy to disassemble, refurbish if needed, and reassemble at a new location. Our products are GREENGUARD Gold certified, and highly maintainable with easily available spare parts.



Extended life cycles

The most effective way for manufacturers to reduce the environmental impact of their products is to extend their life cycle. The durability of the all-steel structures of Framery's new products is measured in decades. Modular product structures allow the pods to be easily serviced and refurbished, extending their life cycles even further. At the end of their life, the products are fully recyclable as a result of eliminating composite and other hard-to-recycle materials.



Transportation

Logistical hubs in Singapore and the USA reduces air freight, and allows us to load our shipping containers more tightly. The products are made-to-order, and their modularity helps us achieve this with minimal impact.

Framery Four Accessible™

Technical specifications

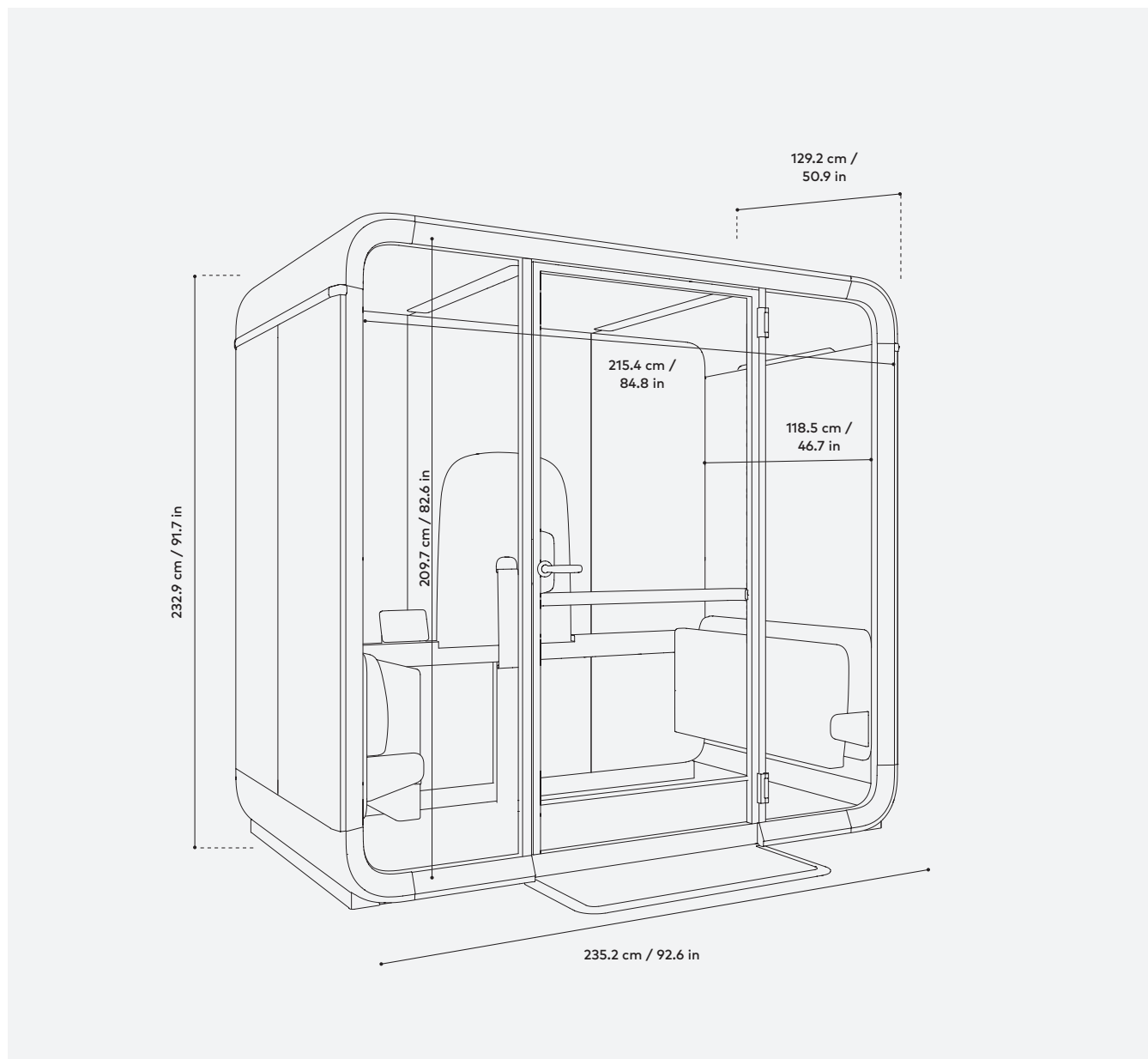

Performance

Speech level reduction: 30dB
Max airflow: 100 l/s
Low energy consumption: 52W

Accessibility

T-shaped turning space
Low threshold and external platform
Folding furniture

Connectivity

Built-in 4G connection
Automatic software updates
Framery Connect digital services

Framery Four Accessible / Technical specifications

OVERVIEW

Soundproofing	CLASS A 30 DS,A (dB) reduction Speech level reduction DS,A (dB) is measured using ISO 23351-1. Pod can be placed next to workspaces without compromising privacy.
Sound masking	FRAMERY OFFICE SOUND MASKING SYSTEM™ A pre-fitted sound masking system improves the soundscape of the office outside the pods with an effective radius of 5 m / 16 ft.
Ventilation	MAXIMUM AIRFLOW 100 l/s, 212 CFM (360.2 m³/h) DEFAULT AIRFLOW 78 l/s, 165 CFM (280 m³/h) when in use. After use, the pod refreshes itself with a higher ventilation speed. STANDBY MODE 40 l/s, 85 CFM, (144 m³/h) ADJUSTABLE DIRECTIONAL AIRFLOW Choose between direct and indirect airflow
Lighting	CEILING LIGHT Color temperature 4000K, illuminance up to 500lux on the table top. VIDEO LIGHT Color temperature 4000K, illuminance up to 350lux on the user's face. PRE-SET LIGHTING MODES Standard mode & Video call mode. Lighting can also be adjusted also manually.
Presence detection	SENSOR TECHNOLOGY mmWave radar
Dimensions	EXTERIOR WITH AIR FILTER HOUSING 232.9 × 235.2 × 129.2 cm / 91.7 × 92.6 × 50.9 in (h, w, d) DOORWAY 209.7 × 96.6 cm / 82.6 × 38 in (h, w) WEIGHT 535 kg / 1179.5 lb. THRESHOLD 1.25 cm / 0.5 in
Connectivity	Framery smart pods gather anonymous occupancy data, measuring when and how often spaces are used. Users in the space cannot be identified and no personally identifiable data is collected. The anonymous data is transferred via built-in 4G connectivity, or through a Wi-Fi connection and compiled and shown in the Framery Connect platform.

DIMENSIONS / MAIN VIEW

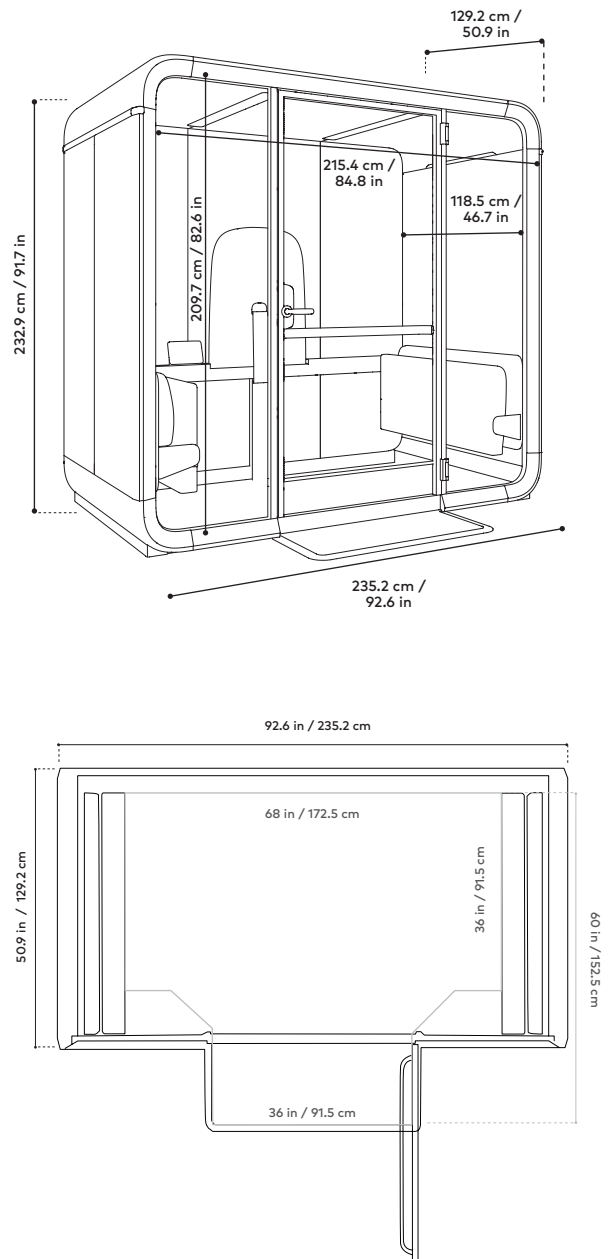

Framery Four Accessible is UL GREENGUARD GOLD certified



Framery Four Accessible shipped in North America is UL 962 listed

Framery Four Accessible / Technical specifications

MATERIALS

Exterior & structure

EXTERIOR PANELS Powder coated matt steel panels
FRAMES Structure matt black aluminum
DOOR FRAME Structure matt black aluminum
GLASS Sound control laminated glass (4 + 4 mm / 0.16 + 0.16 in)
CHASSIS Light steel and PET soundabsorbing structure
HANDLE AND PULL BAR Custom-designed black metal
DOOR KICK PLATES Black metal

Interior materials

INTERIOR PANELS PET sheets laminated with recycled polyester fabric
UPHOLSTERY FABRIC Gabriel Tonal
CARPET Antistatic and stain resistant low loop pile carpet
TABLE TABLE TOP is birch plywood laminated with white, black anti-fingerprint, or oak veneer.
TABLE LEG AND ACCESSORY RAIL
 Structure black metal

Seating materials

UPHOLSTERY FABRIC Gabriel Select
FABRIC COMPOSITION 85 % New Zealand wool / 15 % Polyamide

Furniture dimensions

FOLDING TABLE 63.3 x 87 cm / 24.9 x 34.3 in (w, d). Fixed height from floor 72 cm / 28.3 in. Forces: max 22.2N
FOLDING SOFA width 110 cm / in. Fixed seating height from floor 48.5 cm / 19 in. Max load for the sofa: 408 kg / 900 lb.
PULL BAR Height from pod floor: 92.1 cm / 36.3 in.

Optional accessories

COAT HOOKS Structure black metal
EXTERIOR TABLET MOUNT With easy set-up.

DIMENSIONS / TOP VIEW

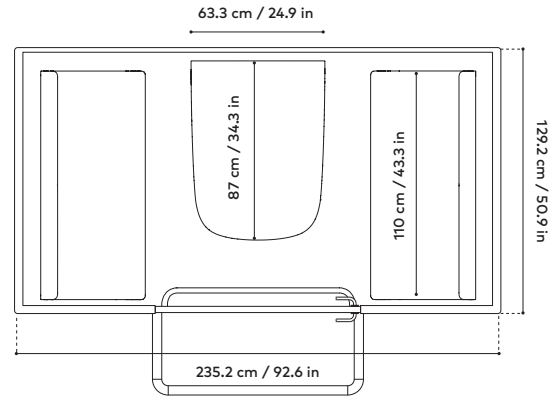

SAFETY

Fire safety

No fire hazardous materials are used in Framery pods. The fire safety of all surface materials, upholstery and acoustics materials of our products are tested and classified by either national or international standards. Framery provides additional safety measurements to adhere to local regulatory requirements.

Seismic safety

A seismic anchoring kit for a pod is available for the seismic regions. The kit consists of brackets that further reinforce the pod structure to withstand heavy seismic forces.

Framery Four Accessible / Technical specifications

POWER AND SPACE REQUIREMENTS

Power	<p>FRAMERY FOUR ACCESSIBLE OUTLETS 4 × power outlets (2 on both sides of the table attached to the accessory rail). Optional additional outlets (max 4): 0–2 × USB-C PD charge ports (65 W), 0–4 × LAN ports (with cables)</p> <p>POWER CONSUMPTION Default settings 52W. Highest settings 115W. Standby mode 20W.</p> <p>INPUT 100–240 VAC, 10 A, 50–60 Hz</p> <p>OUTPUT AC (POWER OUTLET) 100–240 VAC (8 A max) 50–60 Hz</p> <p>OUTPUT USB-C PD CHARGE PORT 65W</p>
Space requirements	DOOR OPENING RATIO 180°
Door handedness	Left-handed by default (can also be installed right-handed)
Operating space	From back to front (pod depth + doorway) 225.8 cm / 88.9 in. Room height requirement 235 cm / 92.5 in
Installation space	Installation requires 50 cm / 19.7 in of free space around the pod
Movability	Relocate the pod without the need for disassembly by adding casters with a movability kit. Compatible with Framery Four and Six. The kit is reusable. Multiple pods can be moved with one kit.

SHIPPING CRATE DIMENSIONS

Crate 1	<p>SIZE 226 × 75 × 138 cm / 90 × 29.5 × 54.3 in (l, w, h). WEIGHT 180-238kg / 396-524 lb</p>
Crate 2	<p>SIZE 224 × 74 × 114 cm / 88.2 × 29.1 × 44.9 in (l, w, h). WEIGHT 395 kg / 870.8 lb</p> <p>Crate 1 is stacked on top of Crate 2.</p>

DIMENSIONS / POWER CORD SPECIFICATIONS

Total power cord length: 7 m / 23 ft When installed from the roof: 4 m / 13 ft When installed from the base: 6.5 m / 21 ft

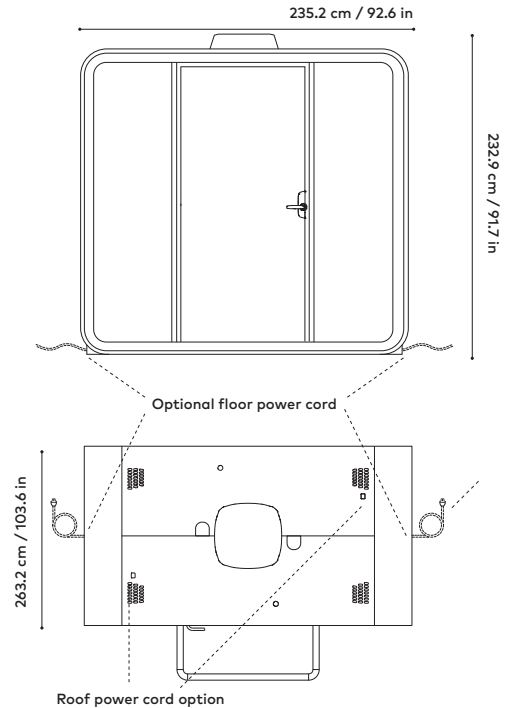

DIMENSIONS / OPERATING SPACE

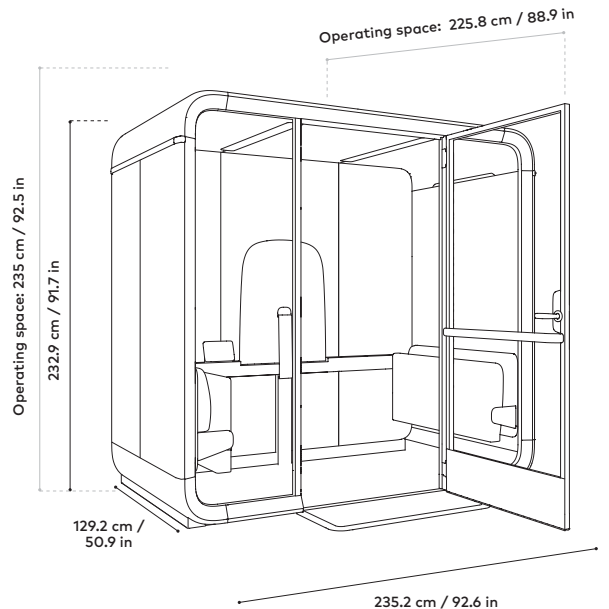

For the doers,
leaders, thinkers,
dreamers, creators,
teams, pioneers
and innovators.
**For people who
get it done.**